



GT01 - Grue à tour MK88+ - Liebherr MK 88 +

Nouveauté chez MB Groupe à partir de juillet 2022 : l'arrivée de la grue tour mobile GT01 Cette grue mobile Liebherr MK88-4.1 PLUS est compacte et maniable (16m de long et 4m de haut pour le transport), d'une capacité de levage de 8T et d'une portée maximale de 45m.



Réf MB	GT01
Infos	cabine réglable en hauteur - groupe électrogène diesel économique et silencieux
Longueur (châssis, sans la flèche dépassante) (m)	16
Largeur (m)	2,75
Hauteur (m)	4
Capacité Max de levage (t)	8
Portée Max (m)	45
Hauteur sous crochet max (m)	59,1
Positions de flèches	15° / 30° / 45°
Charge max au bout de flèche	2,2t
Type	Liebherr MK 88 +

Diagramme de levage avec contrepoids 2to

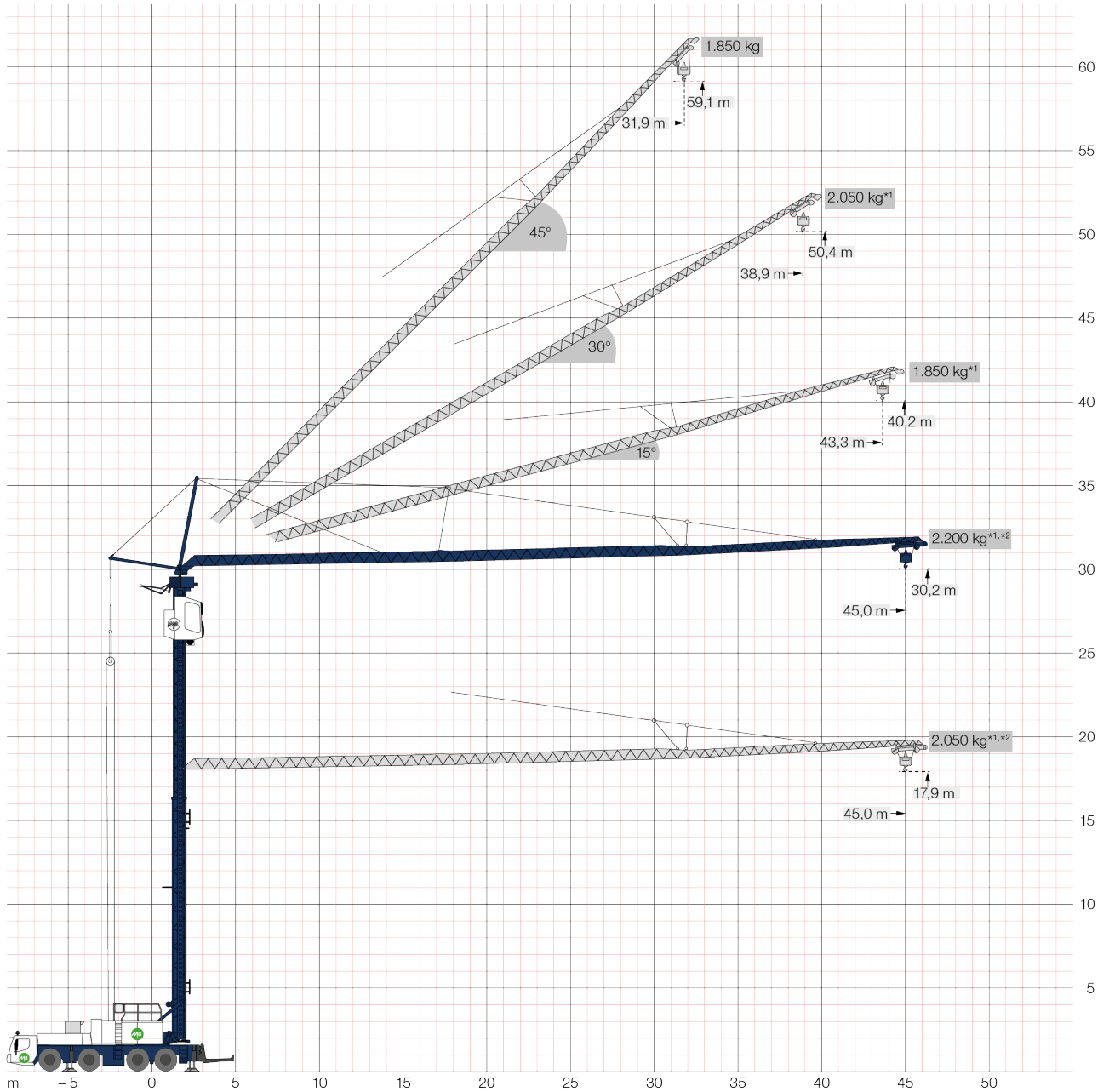

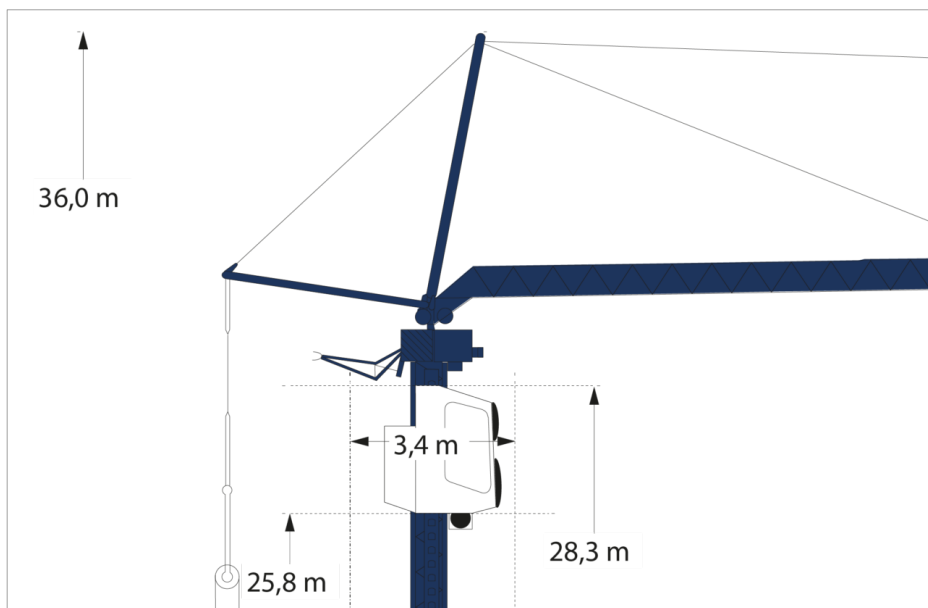
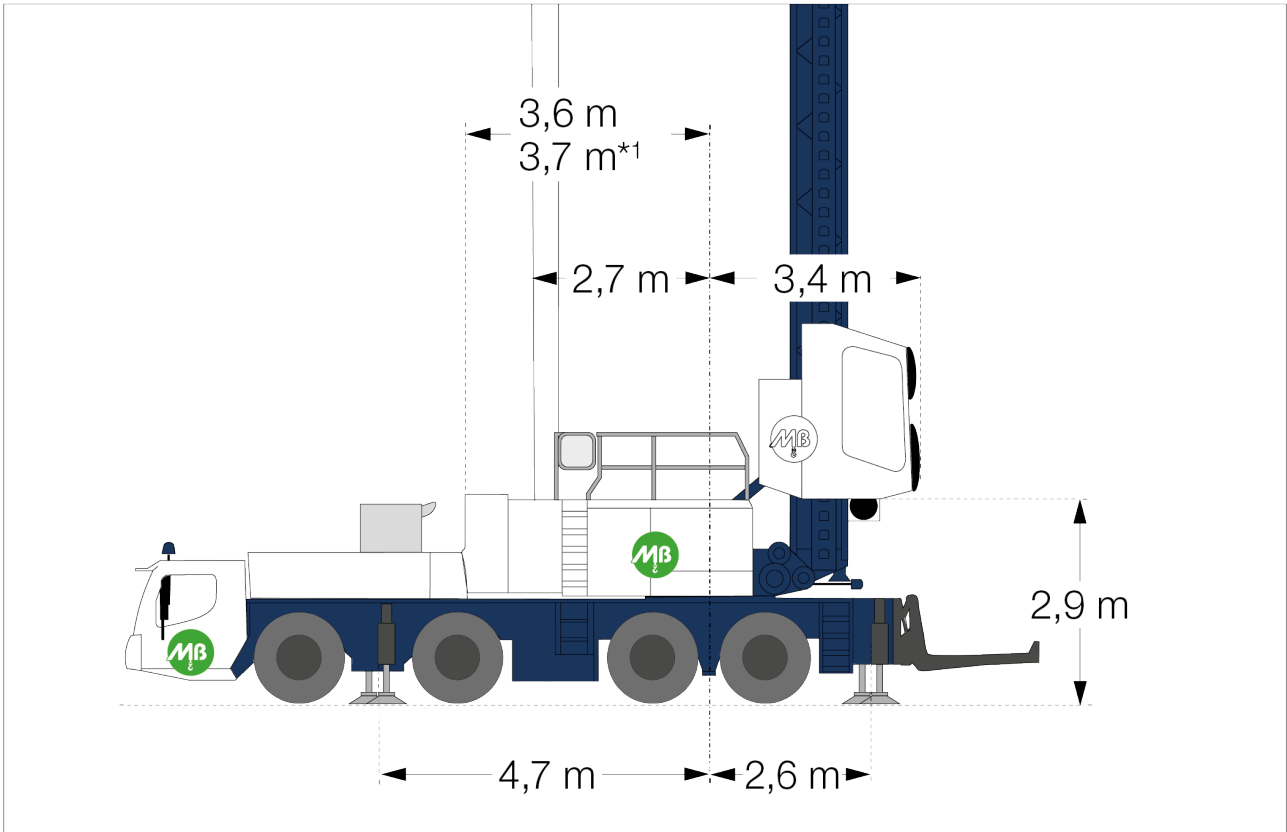











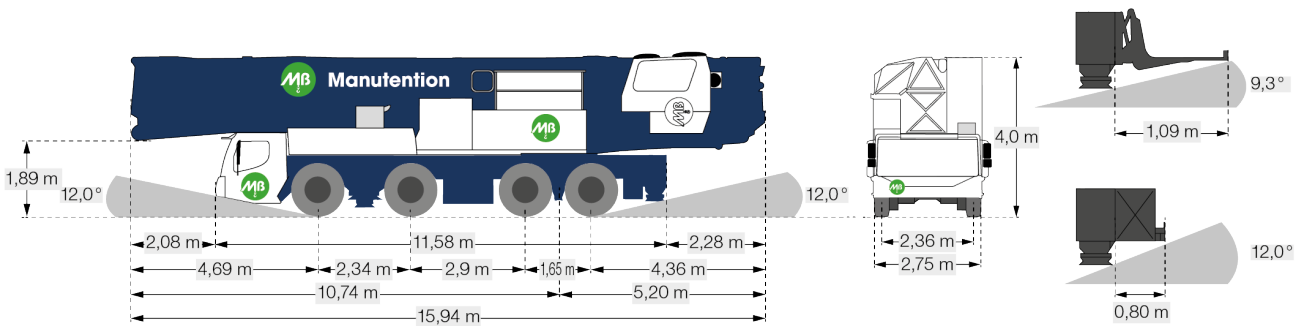
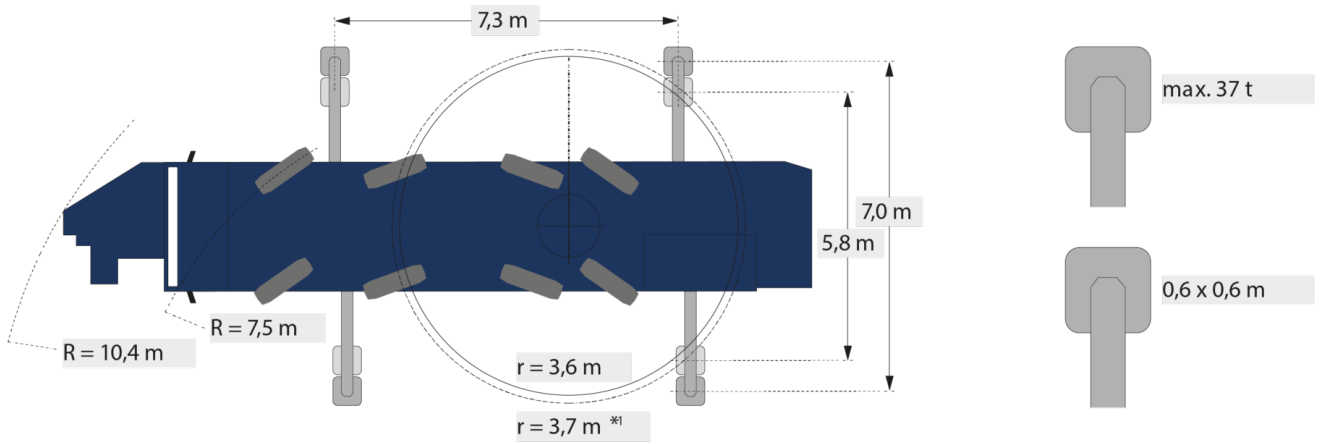
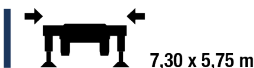





Tableau de charge en demi béquille



7,30 x 5,75 m

				m																		
α°	m	kg	10,0	12,0	14,0	16,0	18,0	20,0	22,0	24,0	26,0	28,0	30,0	32,0	34,0	36,0	38,0	40,0	42,0	44,0	45,0	
0°	45,0	 3,3 - 10,5	8000	8000	6930	5870	5080	4470	3980	3580	3250	2970	2730	2520	2340	2180	2030	1910	1790	1690	1590	1550
		 3,3 - 9,3	8000	7410	6100	5170	4480	3940	3500	3150	2860	2610	2400	2210	2050	1910	1780	1670	1570	1470	1390	1350
15°	43,3	 3,3 - 11,5	8000	8000	7620	6410	5510	4830	4280	3840	3480	3170	2910	2690	2490	2320	2170	2030	1910	1800	1700	1650
		 3,2 - 36,0	1850	1850														1740	1650	1560	1500	
	Plus	 3,2 - 34,0	1850	1850														1400				
		 3,2 - 26,0	2600	2600						2410	2250	2100	1970	1850	1740	1650	1560	1500				
30°	38,9	 3,2 - 24,7	2600	2600						2470	2280	2120	1980	1850	1740	1630	1540	1460	1400			
		 3,0 - 11,0	6000	6000	5580	4880	4320	3880	3510	3200	2930	2700	2500	2330	2180	2040	1910	1750				
45°	31,9	 3,0 - 9,0	6000	5480	4650	4030	3540	3150	2830	2570	2340	2150	1980	1830	1700	1590	1490	1350				
		 2,7 - 31,9	1850	1850																		
	Plus	 2,7 - 24,0	1850	1850														1600				
		 2,7 - 28,3	2800	2800						2670	2430	2230	2050	1900								
	 2,7 - 19,5	2800	2800						2730	2460	2230	2040	1870	1730	1600							













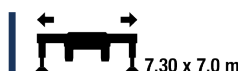



 = max. 14,1 m/s (6,5 Bft)  = max. 17,0 m/s (7,0 Bft)  = max. 20,0 m/s (8,0 Bft)

Tableau de charge en béquille max



7,30 x 7,0 m

				m																		
α°	m	kg	10,0	12,0	14,0	16,0	18,0	20,0	22,0	24,0	26,0	28,0	30,0	32,0	34,0	36,0	38,0	40,0	42,0	44,0	45,0	
0°	45,0	 3,3 - 12,0	8000	8000	8000	6910	6080	5410	4870	4420	4050	3730	3450	3200	2990	2800	2630	2480	2340	2220	2100	45,0
		 3,3 - 11,0	8000	8000	7370	6360	5580	4960	4460	4050	3700	3400	3140	2920	2720	2540	2390	2250	2120	2000	1900	2050
	Plus*2	 3,3 - 13,0	8000	8000	8000	7510	6670	5990	5420	4931	4520	4160	3840	3560	3320	3100	2900	2720	2550	2400	2260	1850
15°	43,3	 3,2 - 43,4	1850	1850														2200				
		 3,2 - 38,2	1850	1850														1600				
	Plus	 3,2 - 32,0	2600	2600						2580	2400	2240	2100	1970	1860	1760	1660	1600				
		 3,2 - 27,8	2600	2600						2580	2400	2240	2100	1970	1860	1760	1660	1600				
30°	38,9	 3,0 - 12,0	6000	6000	5050	4560	4150	3810	3510	3250	3030	2830	2650	2490	2350	2220	2050					
		 3,0 - 9,0	6000	5620	4970	4450	4020	3660	3360	3100	2870	2670	2490	2340	2200	2070	1950	1800				
45°	31,9	 2,7 - 31,9	1850	1850																		
		 2,7 - 28,3	1850	1850														1600				
	Plus	 2,7 - 23,0	2800	2800						2670	2430	2230	2050	1900								
	 2,7 - 19,5	2800	2800						2730	2460	2230	2040	1870	1730	1600							

